







A	B	C	D	E	F
 M8x20	 M5			 3.5x30	 Ø5
8 PCS	1 PC	2 PCS	4 PCS	4 PCS	16 PCS

FIG.
1







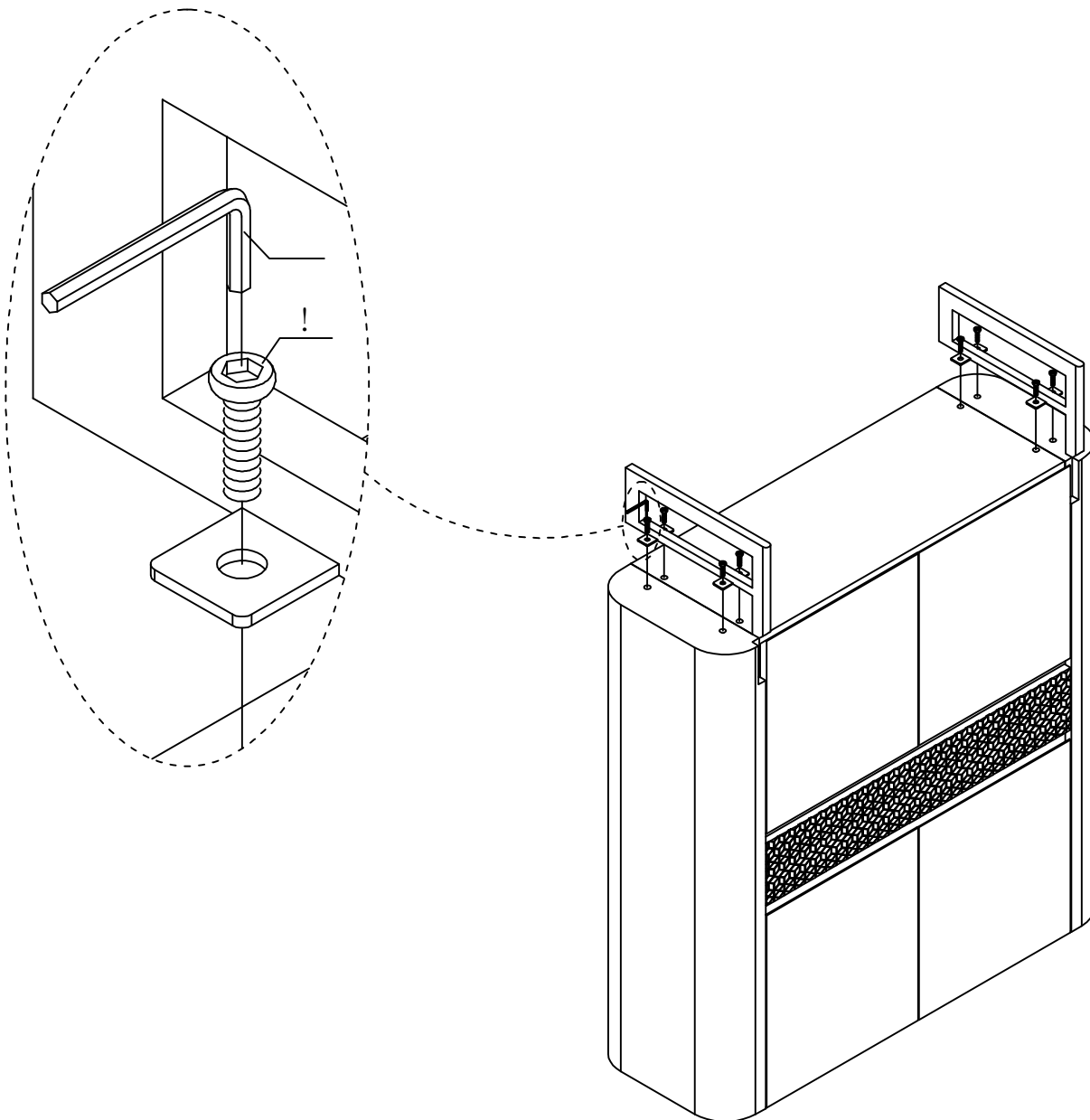

A	B	C	D	E	F
 M8x20	 M5			 3.5x30	 Ø5
8 PCS	1 PC	2 PCS	4 PCS	4 PCS	16 PCS

FIG.
2





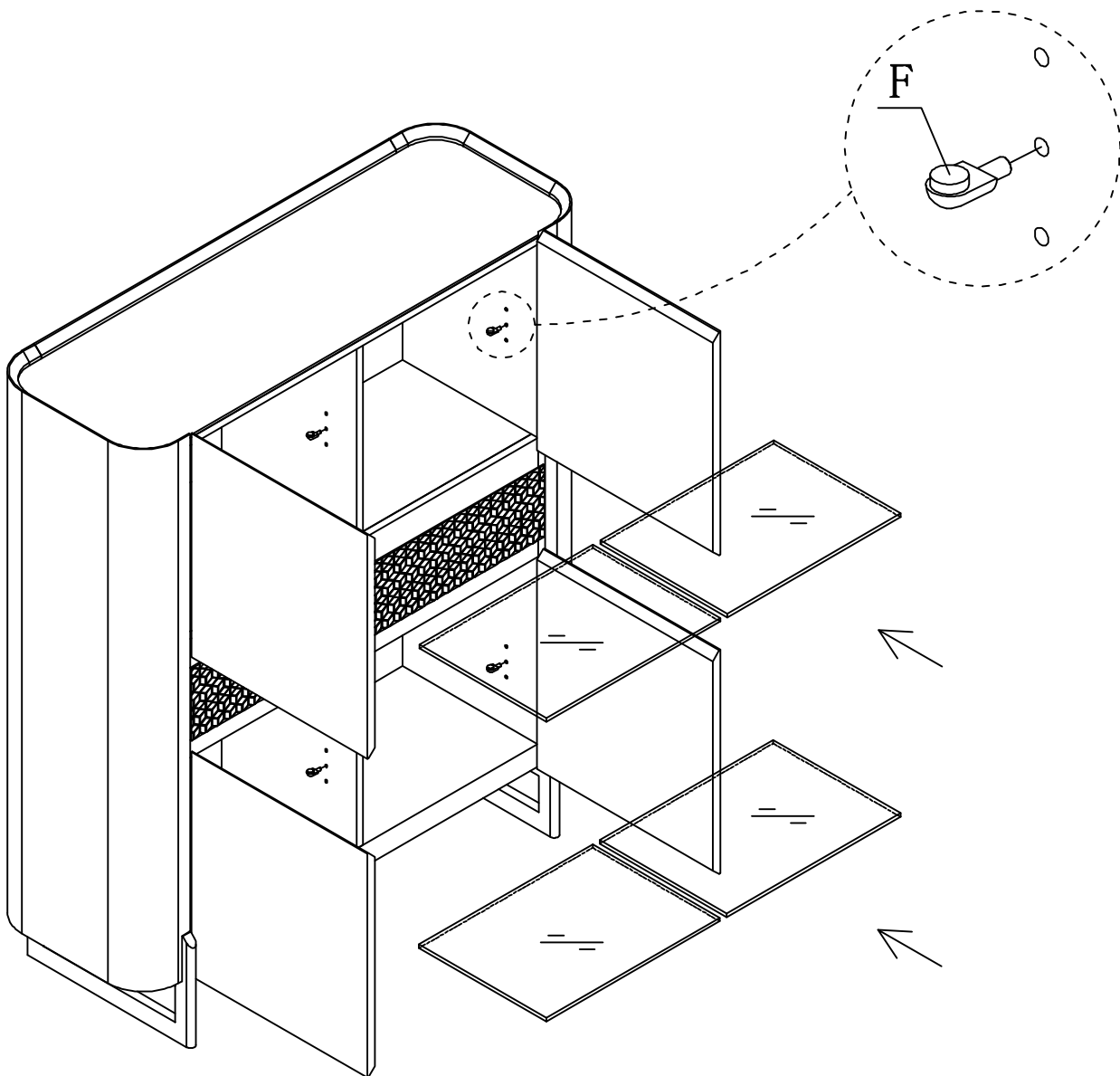

A	B	C	D	E	F
 M8x20	 M5			 3.5x30	 Ø5
8 PCS	1 PC	2 PCS	4 PCS	4 PCS	16 PCS

FIG.
3

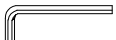
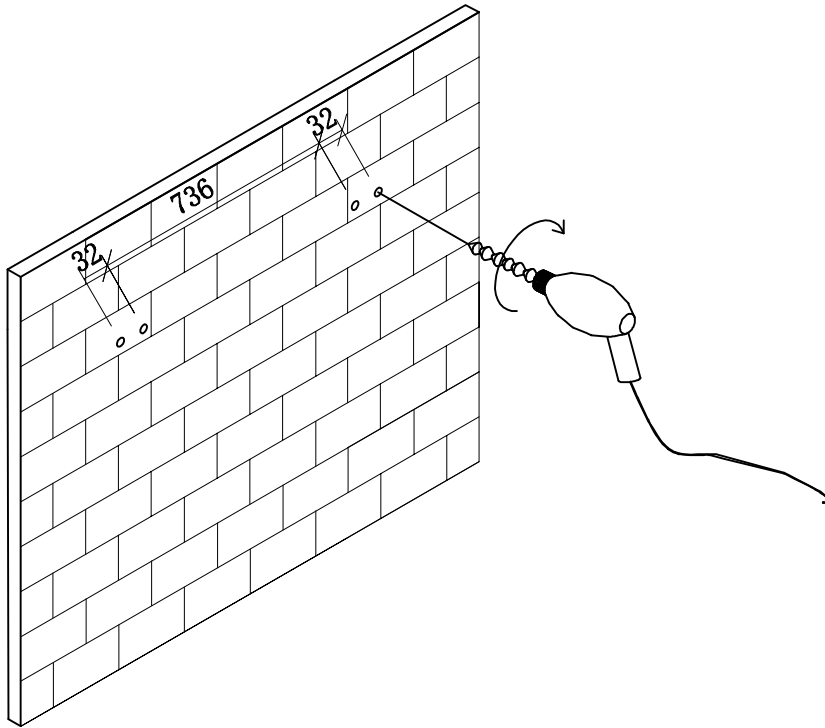
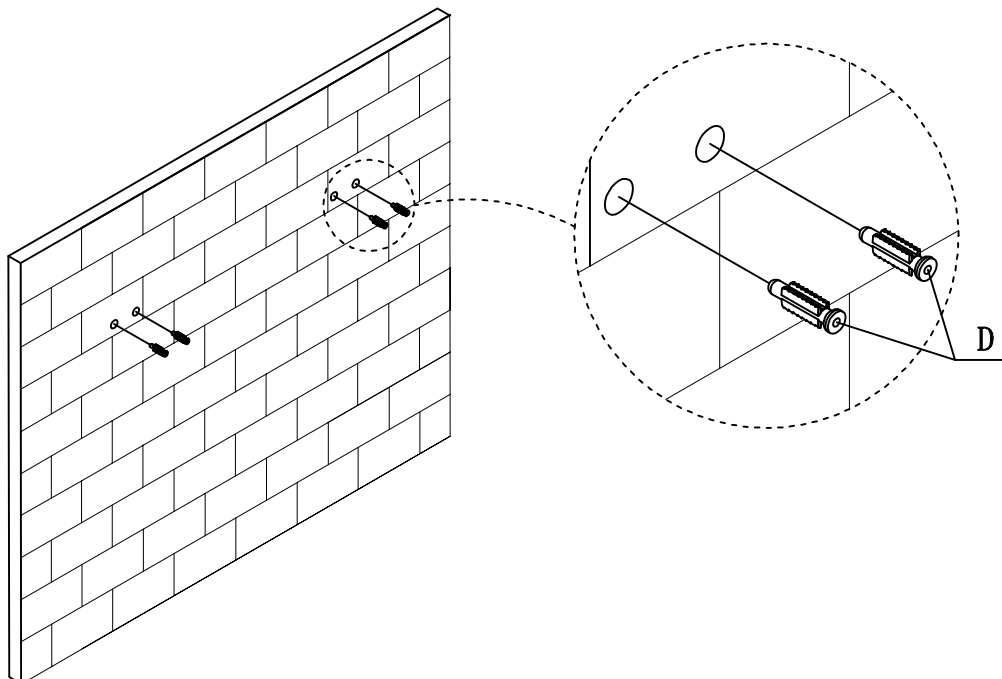

FIG.
4







A	B	C	D	E	F
 M8x20	 M5			 3.5x30	 Ø5
8 PCS	1 PC	2 PCS	4 PCS	4 PCS	16 PCS

FIG.
5

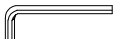
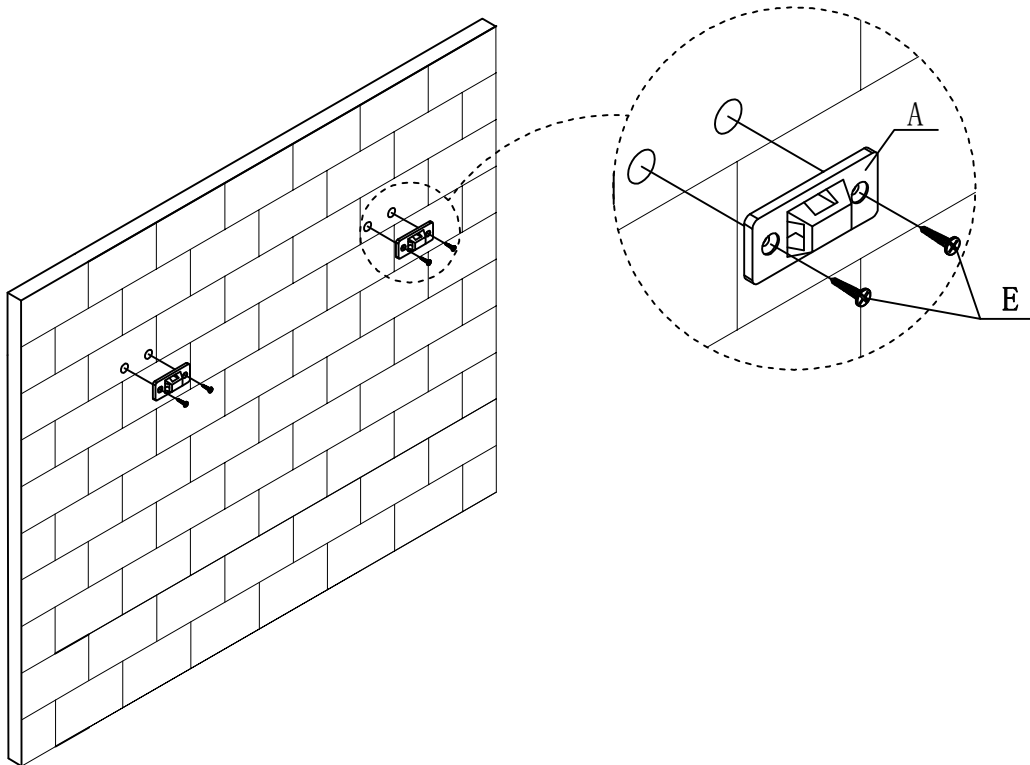

FIG.
6

