

ASSEMBLY INSTRUCTION

4153 - MLM611698 - 2599



A	B	C	D	E	F	G	H
							a x10 M6x22mm b x4 M6x35mm
1 PC	1 PC	2 PCS	1 PC	1 PC	1 PC	5 PCS	14 PCS
I	L	M	K				
1 PC	1 PC	1 PC	8 PCS				

FIG. 1

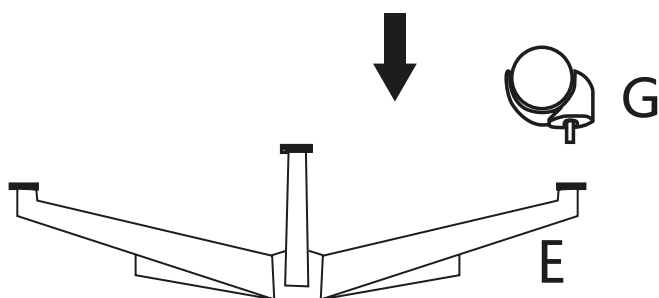

FIG. 2

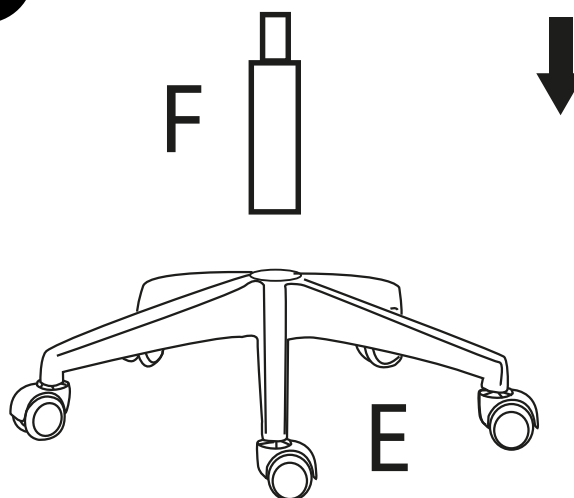

FIG. 3

Assemble the armrest and back firstly.

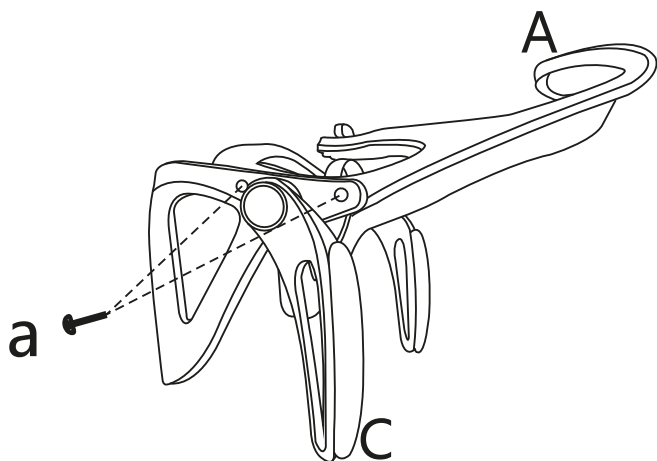
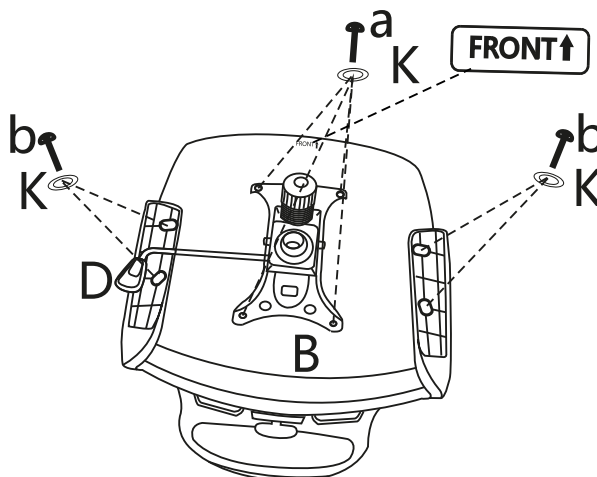

FIG. 4

Assemble the armrest and seat cushion first. After that attach the mechanism on the seat cushion. Please notice the direction!















A	B	C	D	E	F	G	H
							a  x10 M6x22mm b  x4 M6x35mm
1 PC	1 PC	2 PCS	1 PC	1 PC	1 PC	5 PCS	14 PCS
I	L	M	K				
 P5							
1 PC	1 PC	1 PC	8 PCS				

FIG. 5

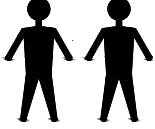
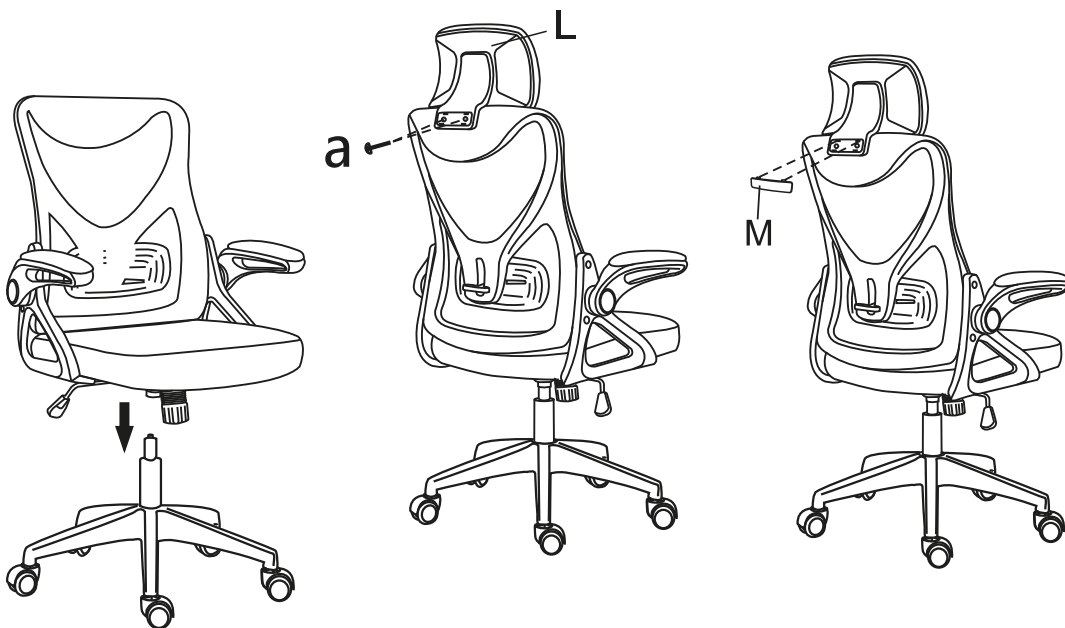

FIG. 6

