









A	B	C	D	E	F
 M8*30	 M8*50	 M8*50		 5mm	
32 PCS	12 PCS	4 PCS	4 PCS	1 PC	2 PCS



**FIG.**  
**1**

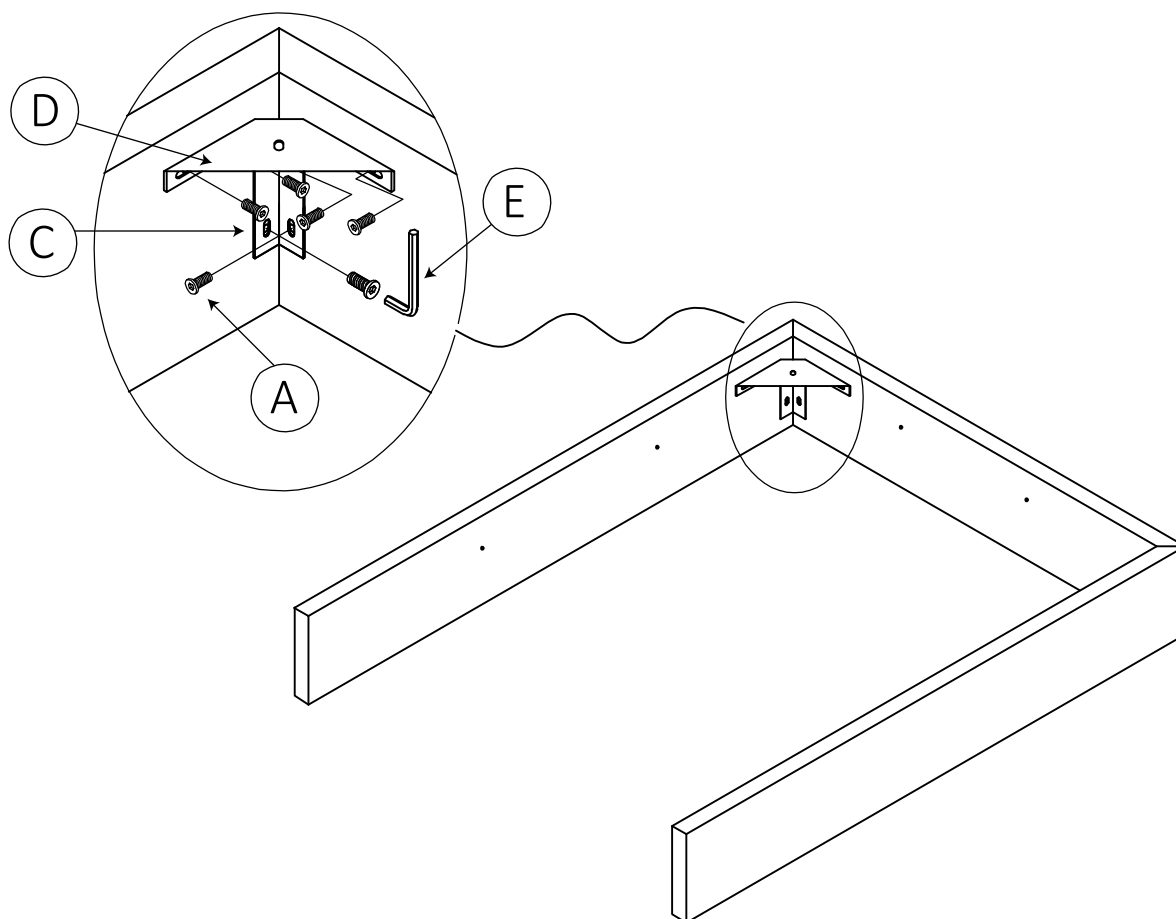

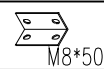
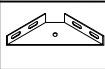
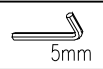
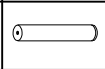



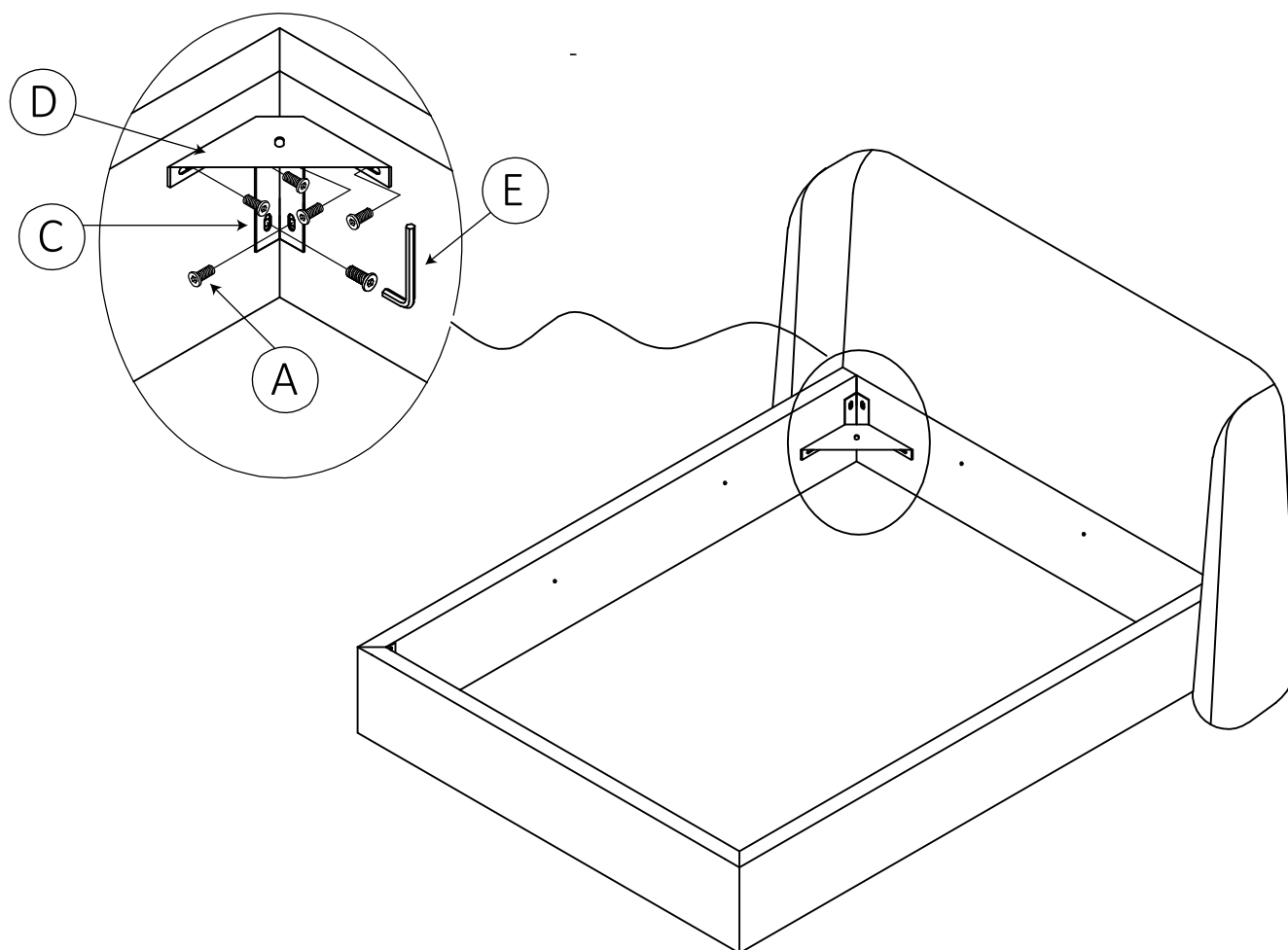

A	B	C	D	E	F
 M8*30	 M8*50	 M8*50		 5mm	
32 PCS	12 PCS	4 PCS	4 PCS	1 PC	2 PCS



**FIG.**  
**2**







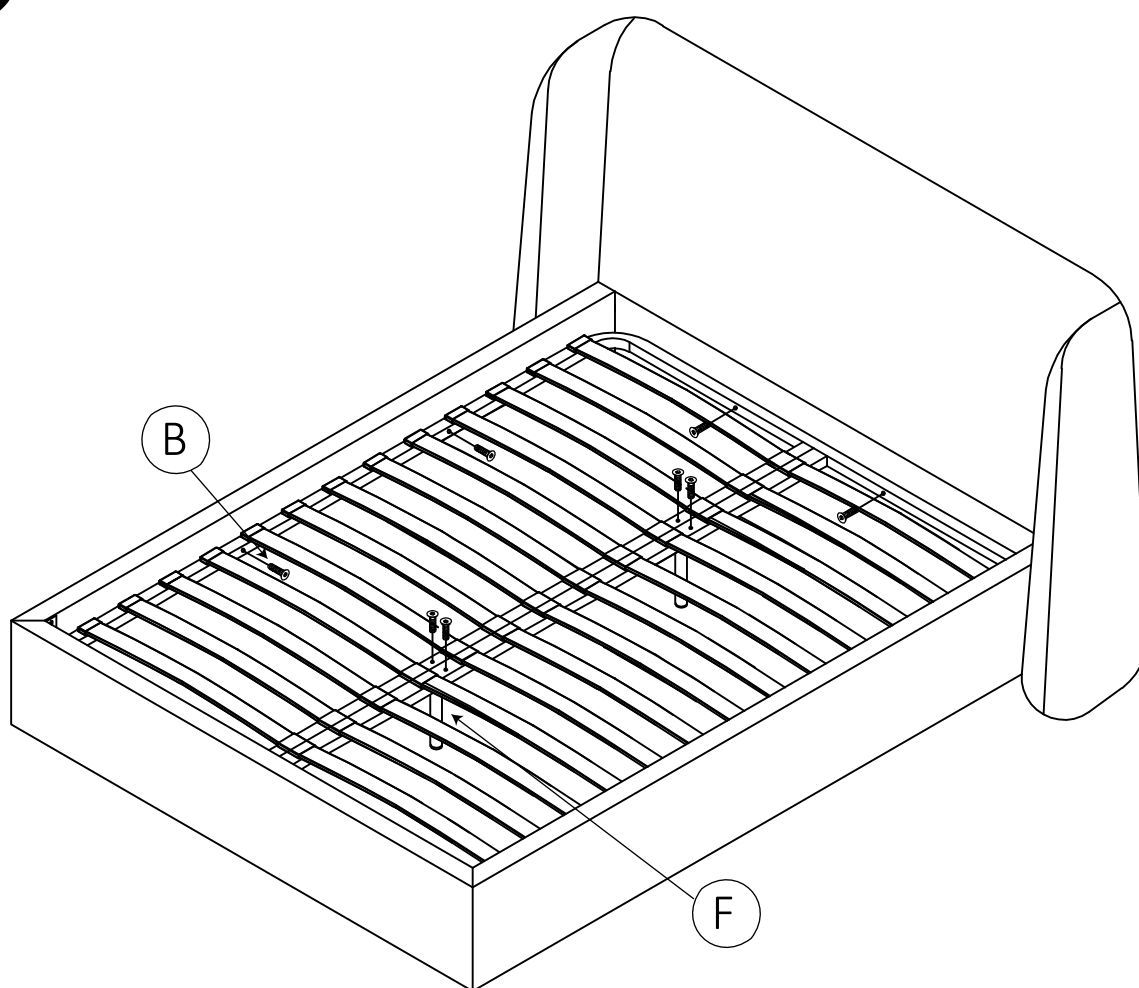

A	B	C	D	E	F
 M8*30	 M8*50	 M8*50		 5mm	
32 PCS	12 PCS	4 PCS	4 PCS	1 PC	2 PCS



**FIG.**  
**3**



A	B	C	D	E	F
 M8*30	 M8*50	 M8*50		 5mm	
32 PCS	12 PCS	4 PCS	4 PCS	1 PC	2 PCS





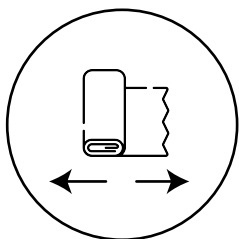
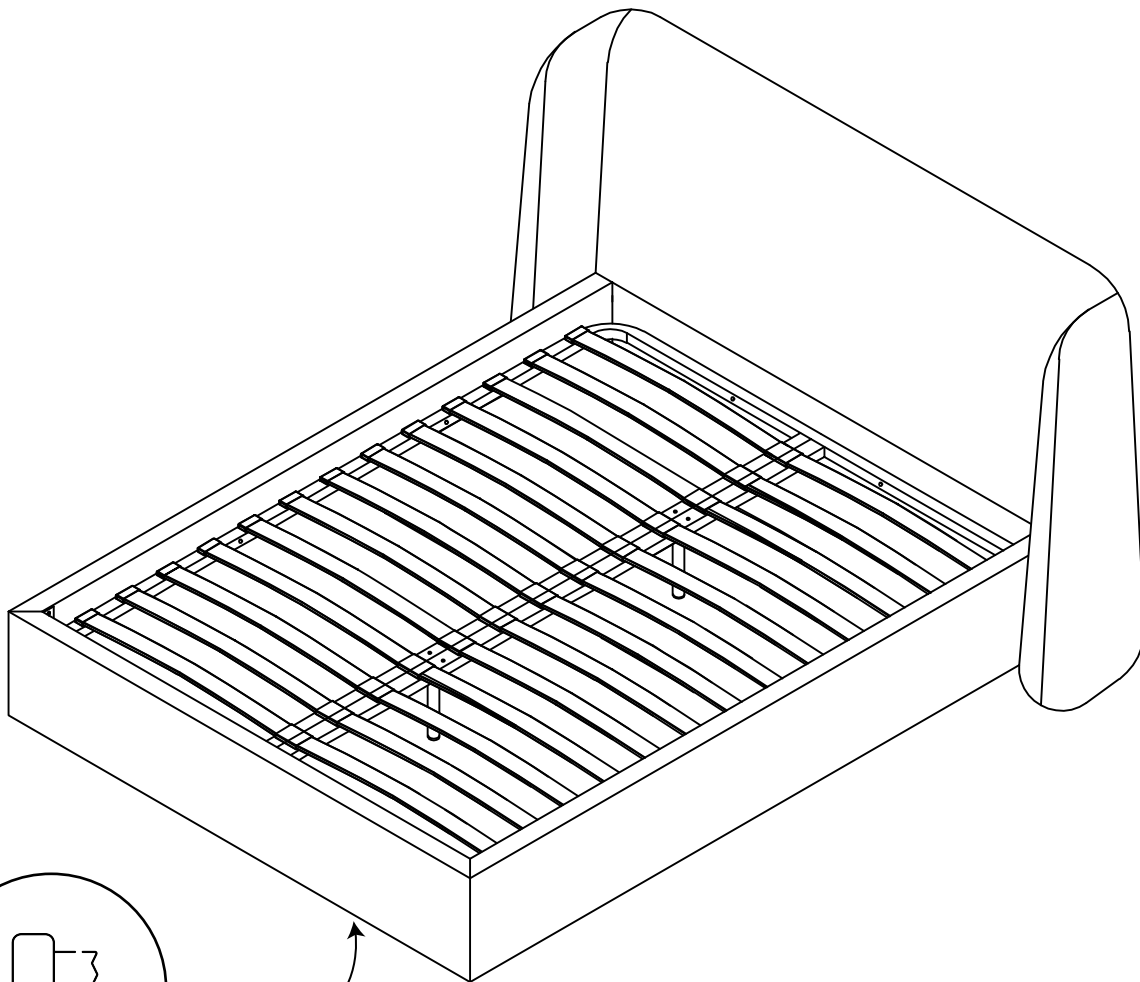
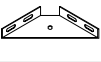

**FIG.**  
**4**

### FABRIC ADJUSTMENT

The fabric is intentionally left loose for transport and must be adjusted during assembly.



Spread out the fabric and adjust it around the upholstered base. Secure the fabric using the Velcro fasteners, pulling it gently to achieve proper tension and a smooth finish.

A	B	C	D	E	F
 M8*30	 M8*50	 M8*50		 5mm	
32 PCS	12 PCS	4 PCS	4 PCS	1 PC	2 PCS



**FIG.**  
**5**

FINISHED

