

ASSEMBLY INSTRUCTION
7224-2782

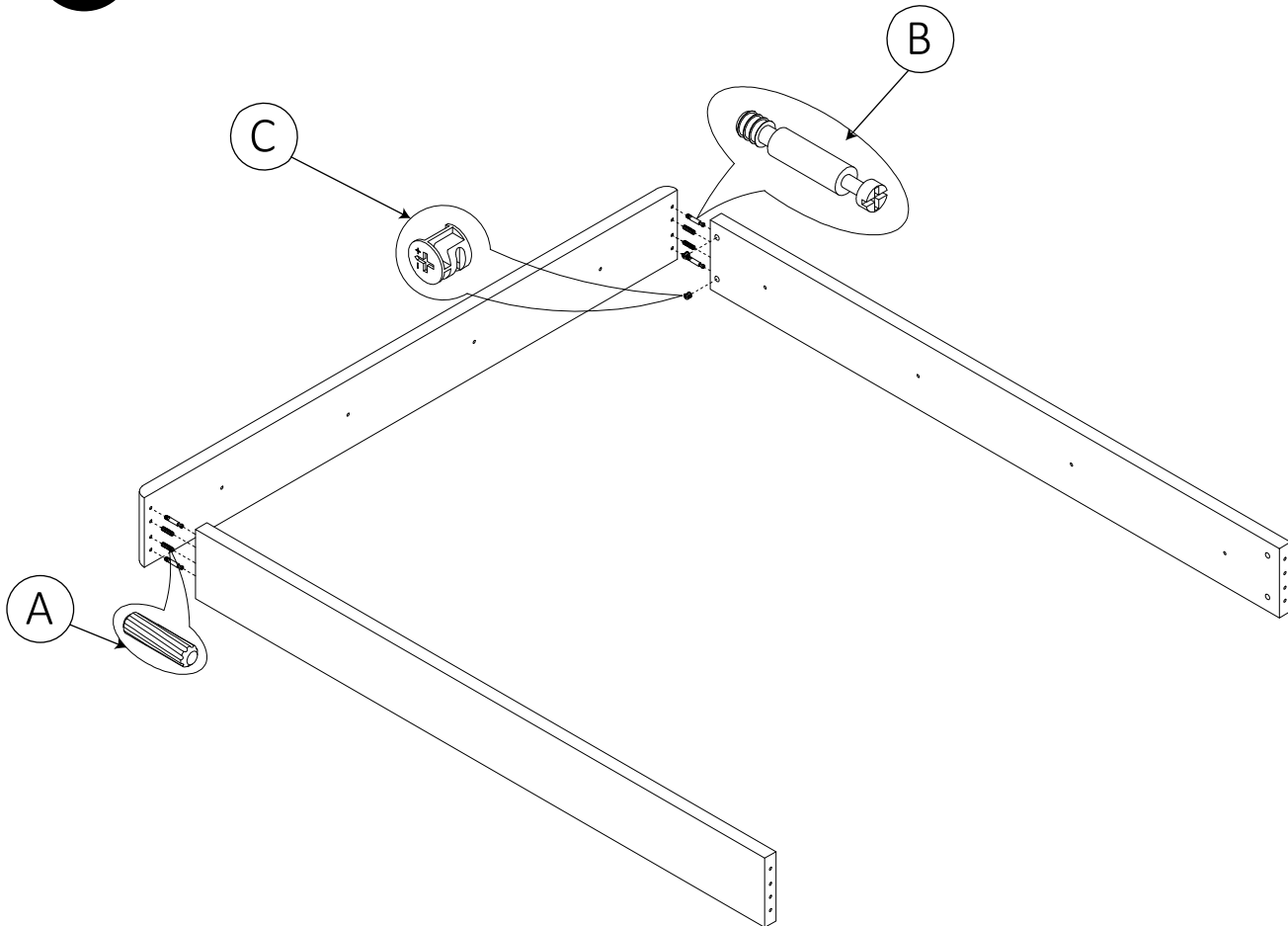

A	B	C	D	E	F	G
Ø10x40	Ø7x30	Ø15x12	M8x60	M8x18	gl. 1 lit	M6x45
8 PCS	4 PCS	4 PCS	4 PCS	4 PCS	1 PC	16 PCS
H	I	J	K			
T	P5	Ø8xØ18	M8x60			
4 PCS	1 PC	28 PCS	8 PCS			

FIG.
1











A	B	C	D	E	F	G
 Ø10x40	 Ø7x30	 Ø15x12	 M8x60	 M8x18	 glue	 M6x45
8 PCS	4 PCS	4 PCS	4 PCS	4 PCS	1 PC	16 PCS
H	I	J	K			
 T	 P5	 Ø8xØ18	 M8x60			
4 PCS	1 PC	28 PCS	8 PCS			

FIG.
2





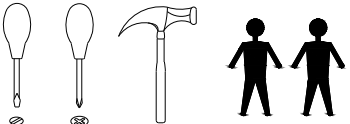

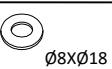
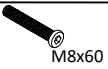
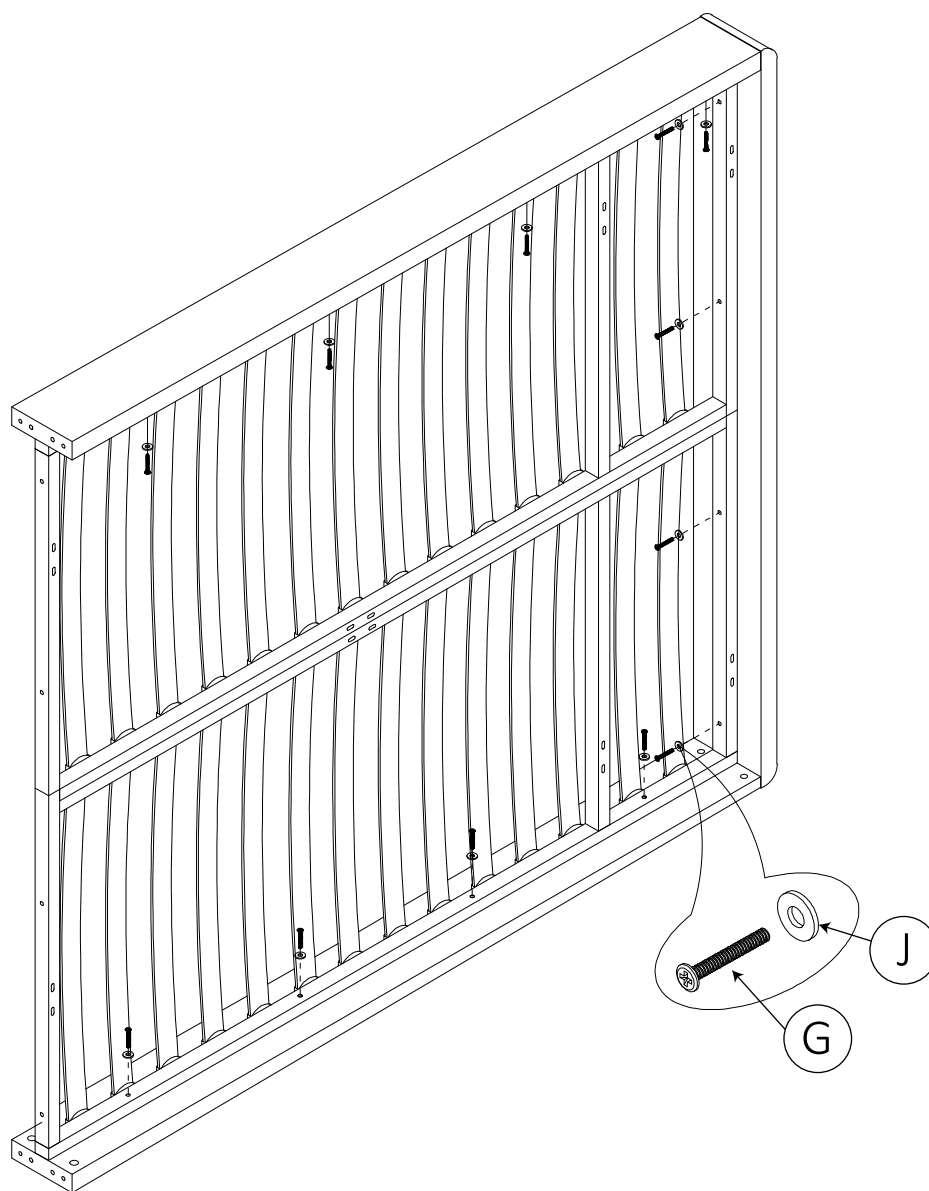







A	B	C	D	E	F	G
 Ø10x40	 Ø7x30	 Ø15x12	 M8x60	 M8x18	 Ø1.146	 M6x45
8 PCS	4 PCS	4 PCS	4 PCS	4 PCS	1 PC	16 PCS
H	I	J	K			
 4 PCS	 P5 1 PC	 Ø8xØ18 28 PCS	 M8x60 8 PCS			

FIG.
3







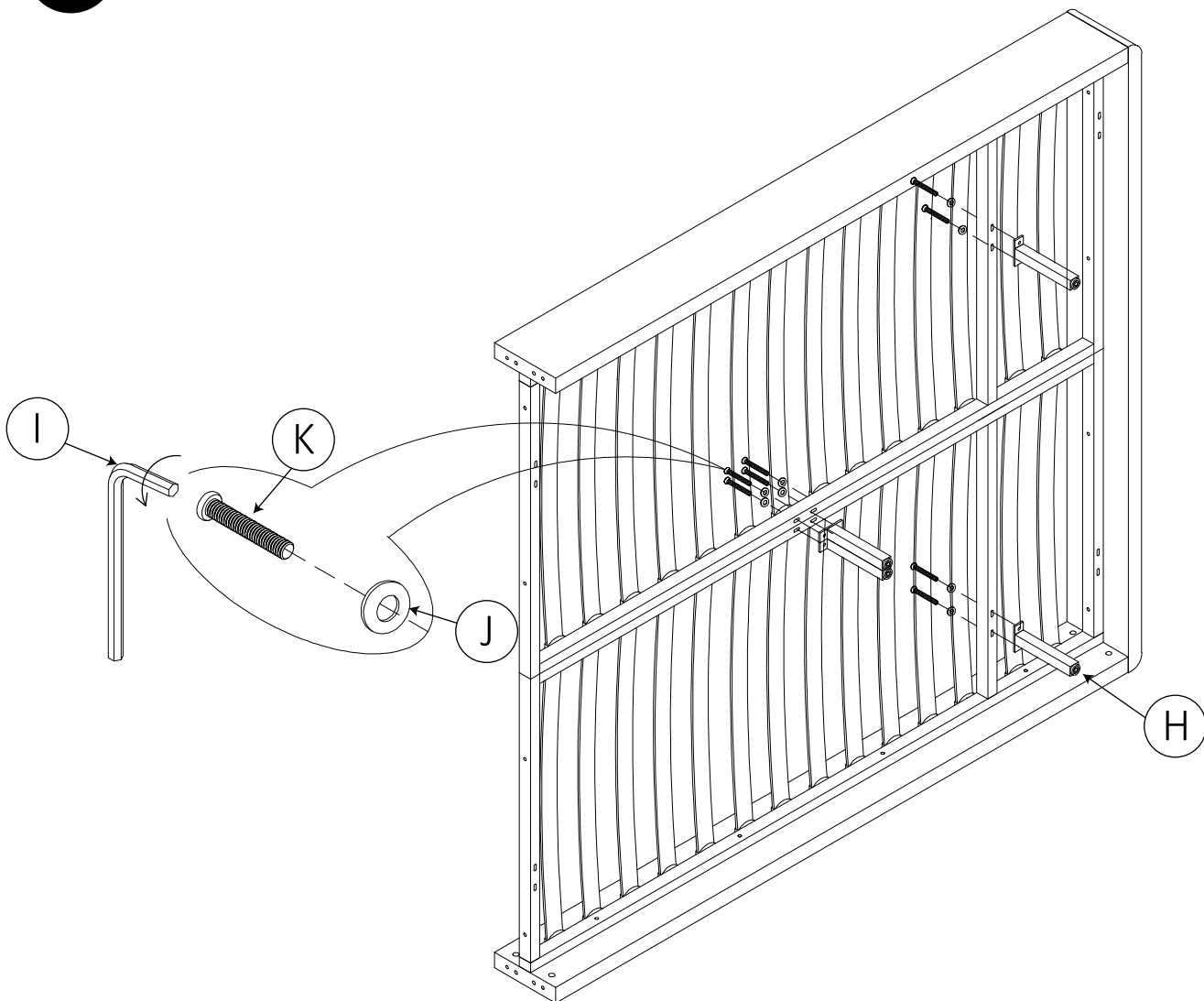





A	B	C	D	E	F	G
 Ø10x40	 Ø7x30	 Ø15x12	 M8x60	 M8x18	 M6x45	 M6x45
8 PCS	4 PCS	4 PCS	4 PCS	4 PCS	1 PC	16 PCS
H	I	J	K			
 4 PCS	 P5 1 PC	 Ø8xØ18 28 PCS	 M8x60 8 PCS			

FIG.
4



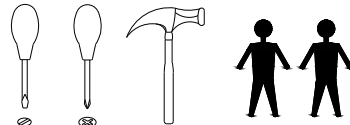

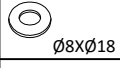

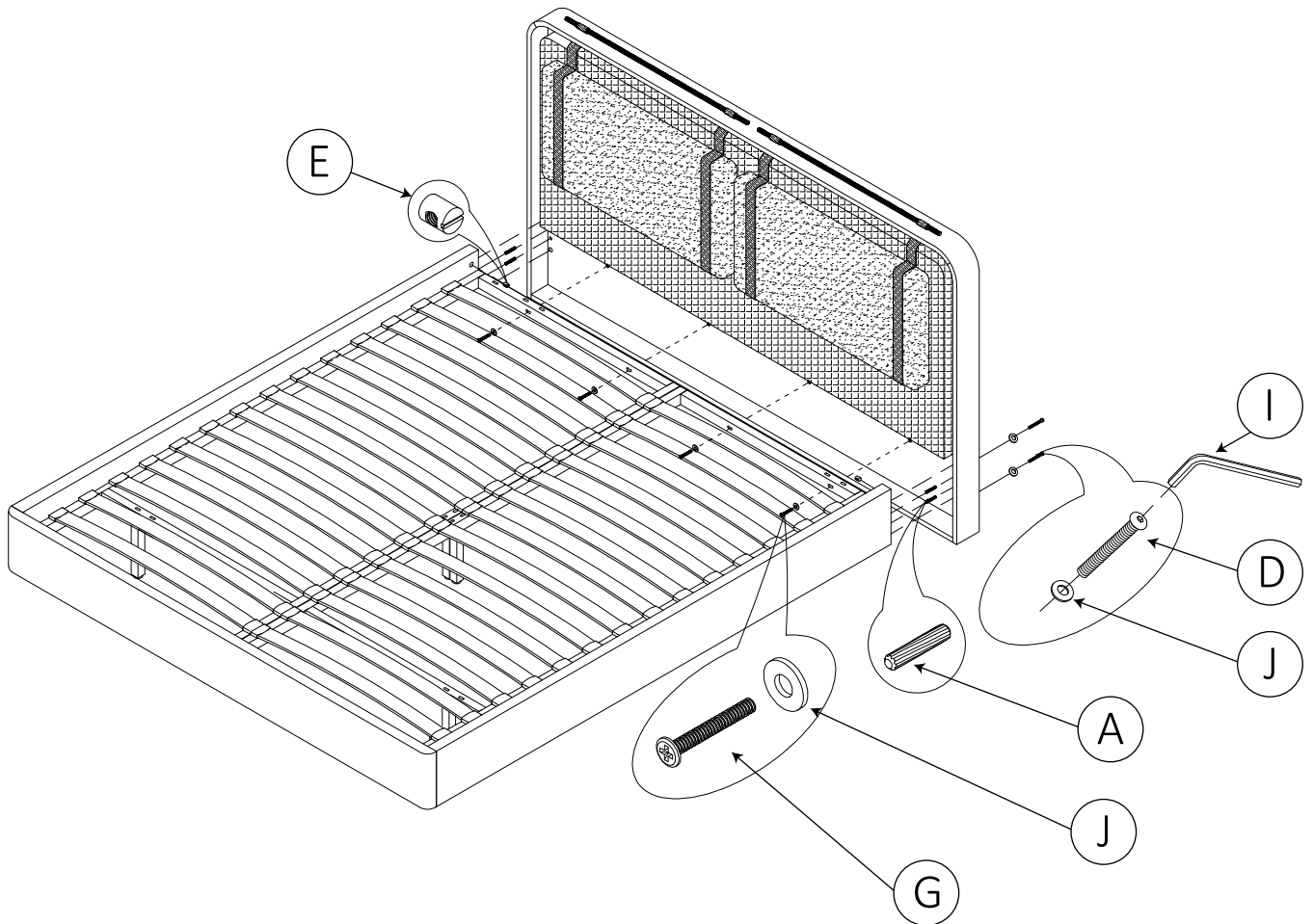







A	B	C	D	E	F	G
 Ø10x40	 Ø7x30	 Ø15x12	 M8x60	 M8x18	 M6x45	 M6x45
8 PCS	4 PCS	4 PCS	4 PCS	4 PCS	1 PC	16 PCS
H	I	J	K			
 4 PCS	 P5 1 PC	 Ø8xØ18 28 PCS	 M8x60 8 PCS			

FIG.
5

